

Radial Duct Inline Fan



Description

The radial duct fan in a housing from galvanized steel sheet can be installed in a variety of mechanical ventilation systems for office rooms, commercial areas, catering space, industrial workshop floors, or cooling systems. The swept-back blade rotors deliver air at maximum efficiency, minimum noise, and high static pressure.

Insulation class: B or F

Maximum operating temperature: +40 °C

Minimum operating temperature: -20 °C

Protection rating: IP55

Product code example

Product code: DV - aaa
 type _____
 ØA _____

*Given the current EU Ecodesign of Energy Related Products Directive, the technical parameters of the fans may vary. See the specifications on the nameplate.

Dimensions

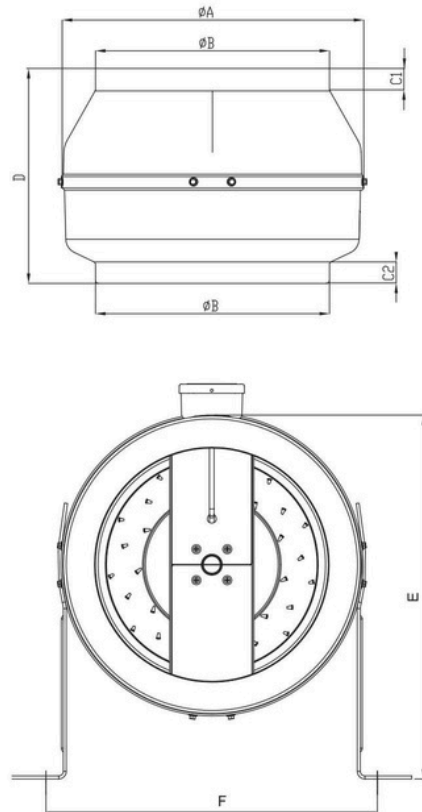

Type	ØA [mm]	ØB [mm]	C1 [mm]	C2 [mm]	D [mm]	E [mm]	F [mm]
DV-100	237	98	26	22	218	276	170
DV-125	237	123	26	20	203	276	170
DV-150	272	147	23	25	192	286	295
DV-160	272	157	23	25	192	286	295
DV-200	330	196	30	28	230	380	352
DV-250	342	248	30	30	227	380	170
DV-315	397	311	26	26	220	437	170
DV-355	400	352	30	30	378	415	422



Get in touch with the Fresh Air Supplies Team!



Call: +44 (0) 28 86752336



Email: sales@freshairsupplies.co.uk

IE: sales@freshairsupplies.ie

Radial Duct Inline Fan



Technical specifications

Type	Voltage [V]	Frequency [Hz]	Maximum power consumption [W]	Rated current [A]	Rotational speed [r p m]	Output [m3/h]	Acoustic pressure [dB(A)]	Insulation class	Protection class [IP]	Weight [kg]
DV-100	230	50/6	68	0,28	2400	400	42	H	4	2,6
DV-125	230	0	76	0,29	2350	500	43	H	4	2,7
DV-150	230	50/6	80	0,4	2450	422	46	B	4	3,0
DV-160	230	0	90	0,43	2550	440	45	B	4	3,2
DV-200	230	50/6	90	0,66	2300	735	46	B	4	4,4
DV-250	230	0	150	0,83	2600	1200	57	F	4	5,5
DV-315	230	50/6	187	1,0	2500	1900	68	F	4	6,9
DV-355	230	50/60	160		1450	1300	45	F	4	9

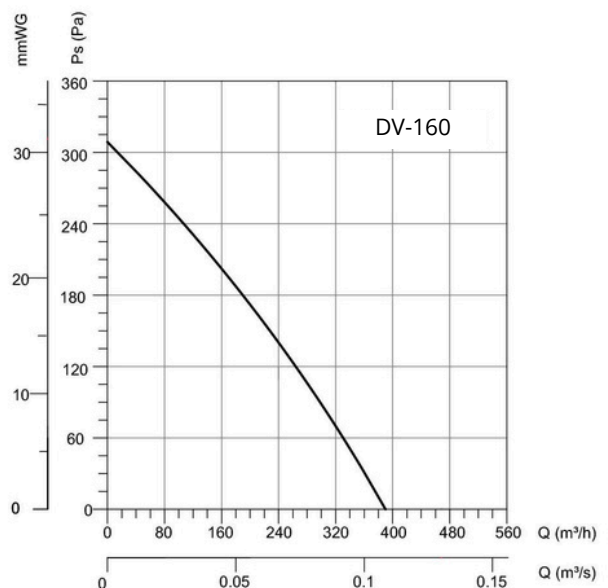
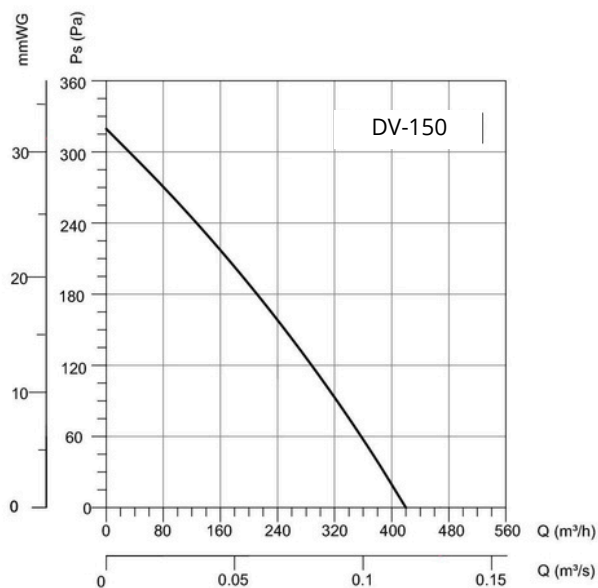
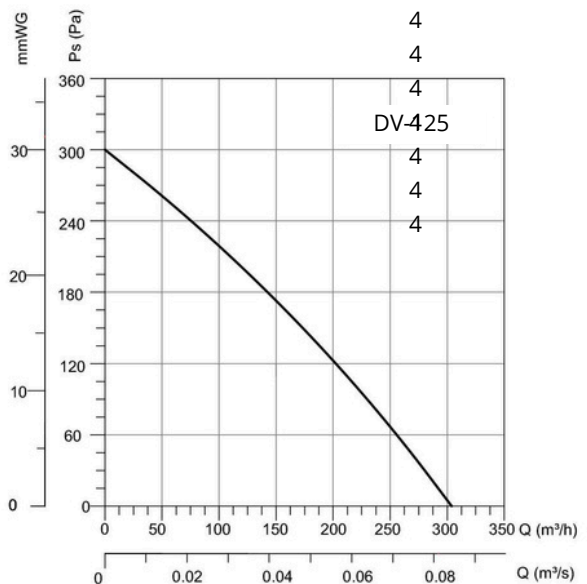
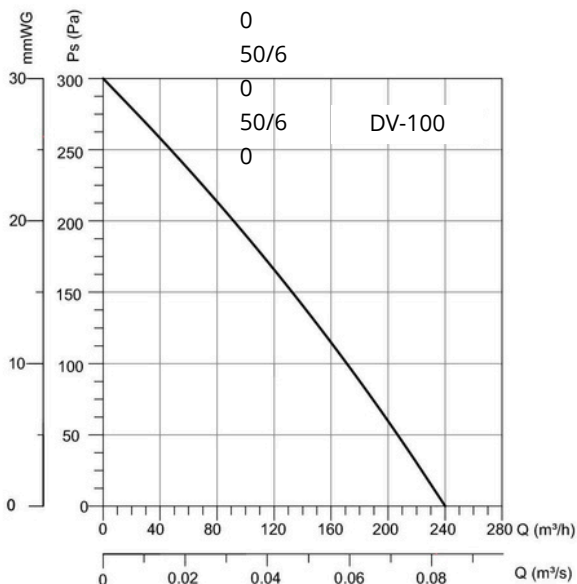

Get in touch with the Fresh Air Supplies Team!

Call: +44 (0) 28 86752336

Email: sales@freshairsupplies.co.uk
IE: sales@freshairsupplies.ie

Radial Duct Inline Fan



Technical specifications

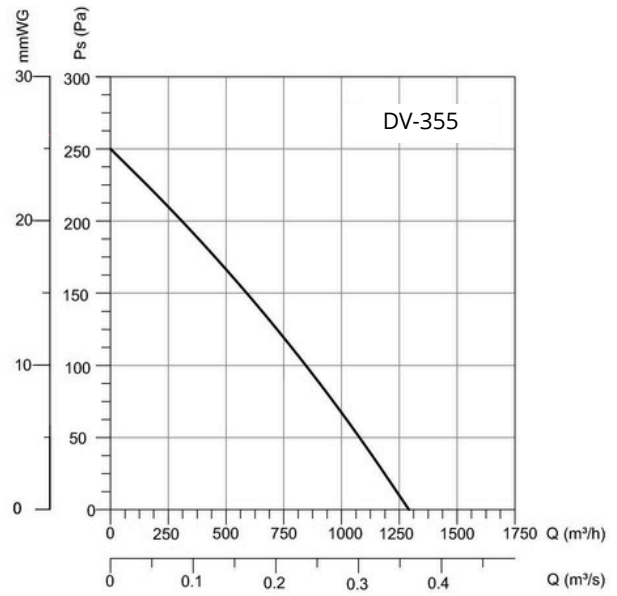
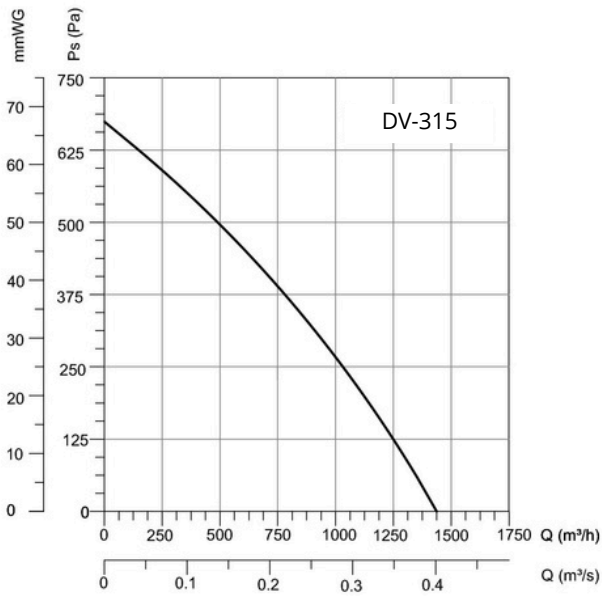
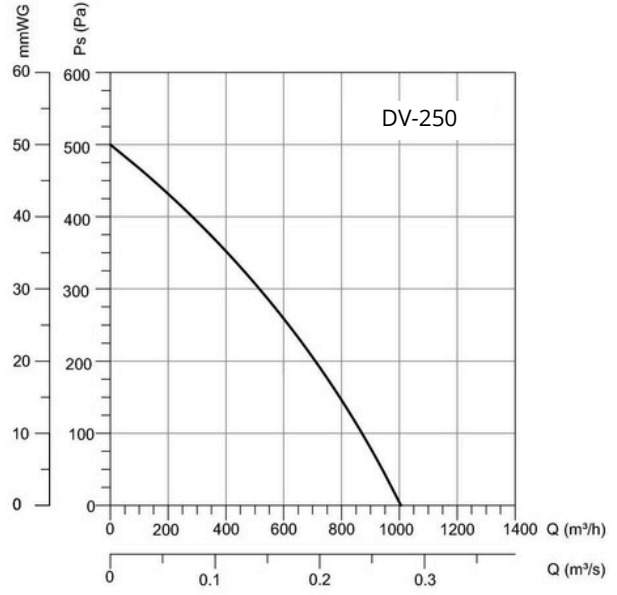
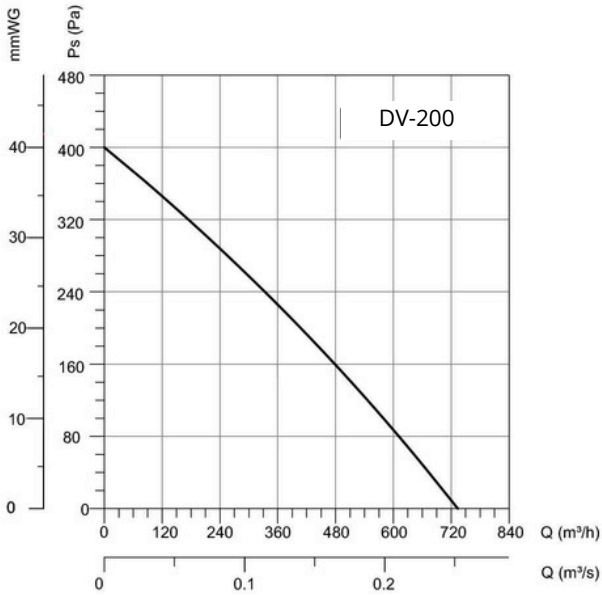

Get in touch with the Fresh Air Supplies Team!



Call: +44 (0) 28 86752336



Email: sales@freshairsupplies.co.uk

IE: sales@freshairsupplies.ie

Radial Duct Inline Fan



Energy class

Model	Noiselevel (dB)	Output (m3/h)	Energy class
DV-100	42	400	F
DV-125	43	500	F
DV-150	46	420	F
DV-160	45	440	F
DV-200	46	735	E
DV-250	57	1200	E
DV-315	68	1900	F
DV-355	66	1300	E

ENERG Y UJA
енергия · ενεργεια IE IA

Nalnor
systemy wentylacji

DV-200

A+
A
B
C
D
E
F
G

46
dB

735 m3/h

ENERGIA · ЕНЕРГИЯ · ΕΝΕΡΓΕΙΑ · ENERGIJA · ENERGY · ENERGIE · ENERGI
2016 1254/2014



Get in touch with the Fresh Air Supplies Team!



Call: +44 (0) 28 86752336



Email: sales@freshairsupplies.co.uk
IE: sales@freshairsupplies.ie